



Wellspring

COMPONENTS, LLC

GRILL CABINETS & EQUIPMENT

INSPIRATIONS. NOT IMITATIONS.



THE WELLSPRING STORY

Four generations ago, in the mid 1950's, a man, who grew up in the hills of the Ohio Swiss Valley gathered a forge, an anvil and the accessories and set up shop outside of Shipshewana, Indiana. He rolled up his sleeves and started serving the surrounding farming community. Big Ben Miller is gone, but his legacy of serving the community continues to this day. The coal forge is in storage and has been replaced by gas-fired furnaces. The anvil sitting in the middle of the action at the metal fab shop of Wellspring Components LLC, is symbolic of the legacy. Fourth generation family members continue to hammer out their creations on the anvil's scarred surface. Now, four generations later, the blacksmith & carriage shop has evolved into multiple divisions serving various markets including the local community.

The Wellspring BBQ division was created after years of endless creations. Needless to say, offering the Big Green Egg, the leader in ceramic grills, created new visions. Today Wellspring manufactures a line of aluminum grill cabinets for all ceramic grills and modular units to create complete outdoor kitchens. They design, manufacture and market commercial, competition,

and backyard barbecue equipment. The latest is a new revolutionary concept of a rotisserie style barbecue cooker for large volumes of chicken, ribs, pork butts or similar meat cuts.

Even though Wellspring utilizes laser cutting, CNC bending, pulse welding and other technologies, it continues to be grounded in that legacy of the anvil, tongs, and fire. Unknown to many, Wellspring is one of few in the world that still forges and heat treats tapered leaf springs as it was done over a hundred years ago for the horse drawn carriage and 1st generation auto industry. Wellspring craftsmen are still grounded in this legacy as they create value with steel, stainless steel, aluminum, and plastic. The aluminum grill cabinet is a good example of these timeless pieces.

Partners: Great nephew: Norman Yoder/Designer

Great, great nephew: Delmer Yoder/Production Manager

Great, great nephew: Arlin Yoder/Sales Manager



At Wellspring, we blend old-fashioned craftsmanship with modern technology like laser cutting, CNC bending, pulse welding, and other technologies, to create products that are both timeless and cutting-edge.



TABLE OF CONTENTS

- | | | | |
|-----------|---|-----------|---|
| 7 | Alpha Series Cabinets | 35 | Classic Collapsible Cabinet Series |
| 14 | Alpha Series Pellet Grill Cabinets | 36 | Classic Value Cabinets |
| 21 | Xpandable Series Cabinets | 37 | Patio Table & Chairs |
| 25 | Xpandable Series Kitchens | 39 | Sauces & Seasonings |

PRODUCT CARE & WARRANTY

Product Care: Use only mild soap with a sponge or soft cloth to clean all powder coated surfaces. Do not use solvents, stainless cleaners or aggressive dish soap. It is recommended to use a Carnauba wax on surface. The powder coated finish & plastic are both high quality exterior products but will be scratched when in contact with sharp or abrasive objects. Use hot plates under all hot items placed on powder coated surface, ensuring there is no debris in between. Do not leave hot or wet ashes on powder coated surface. Plastic doors will warp at very high temperatures. Heat deflection rating is 66 psi at 183 degree F. No warranty on plastic beyond these specs. There is no salt spray specifications or warranty as of 2016.

Warranty: Limited 10 year warranty on material, welds, and powder coating to original owner with regular use and care as intended. 2 year warranty on all hardware, wheels, and the loosening or stripping of all fasteners. Warranty is void if misused, abused, or used in any way other than what the product is intended for. Warranty is void if not cared for as indicated under Product Care. This warranty is strictly with Wellspring Components, LLC. Copy of original invoice from dealer needed to claim warranty. Wellspring will pay freight costs in the first year, after that, shipping is prorated for 5 years. After 5 years no freight allowed.



Big Green Egg

Wellspring
091-002

OLIVE OIL

Worcestershire Sauce



ALPHA SERIES CABINETS

The Alpha Series combines quality, value and convenience all into one, making it a perfect choice. A fully welded body and marine grade doors, paired with stainless steel hardware, ensures that it will serve you and your family for many years to come.

When it comes to your backyard, making the right investment is key, and Wellspring cabinets are here to deliver. Need to rearrange your grilling area? Not a problem! Every cabinet and cart comes with 4" casters that make moving your grill easy! Stainless steel latches and rubber gaskets ensure your accessories, and charcoal, stay dry. Cabinets range from 2 door, 4 door and 6 door, with drawer options

available. The Alpha Series cabinets are directed toward the ceramic kamado style grills but can house gas units as well. Coming in a variety of color options, we are confident we have what you are looking for in every application. Wellspring strives to build valuable cabinets to enhance your outdoor cooking experience.



ASBXTBDGBK



ASBXSVGRSS



ASBXTBBKSS

SOLO

ALPHA SERIES

- 2 Door Aluminum Cart.
- 23" to 29"W x 49" to 55"L x 34"H.
- Available for the Big Green Egg, Kamado Joe, Primo and more.
- Length and Width will vary by Grill Brand.
- Refer to Spec Sheet for Complete Information and Availability.



ASBL2DSVBKBK



ASBX2DSVDGBK



ASBX2DWVBKSS

DUO

ALPHA SERIES

- 4 Door Aluminum Cart.
- 23" to 29"W x 49" to 57"L x 34"H.
- Available for the Big Green Egg, Kamado Joe, Primo and more.
- 2 Door Max Option Available, only for Big Green Egg.
- Length and Width will vary by Grill Brand.
- Refer to Spec Sheet for Complete Information and Availability.

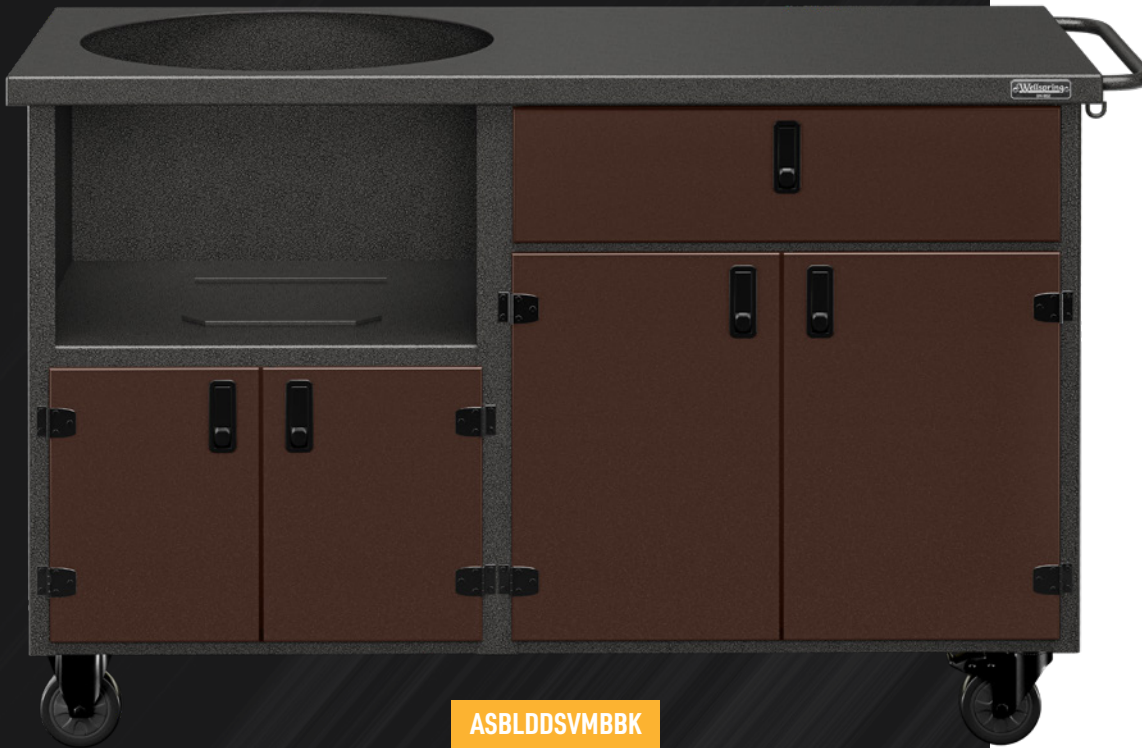

ASBLDDSVMBBK



DUO w/DRAWER

ALPHA SERIES

- 4 Door with 1 Drawer & 1 Towel Bar.
- 23" to 29"W x 49" to 57"L x 34"H.
- Available for the Big Green Egg, Kamado Joe, Primo and more.
- Length and Width will vary by Grill Brand.
- Refer to Spec Sheet for Complete Information and Availability.



ASBLDDTBCHSS



ASBLDDWVGRSS



ASBL1DSVBK BK



ASBLDDSVBK BK

DUO MAX

ALPHA SERIES

- 2 Door with 1 Inner Drawer
- Available only in Silvervein with Black Doors
- 23" to 29"W x 49" to 57"L x 34"H.
- Available for the Big Green Egg and Kamado Joe only.
- Length and Width will vary by Grill Brand.
- Refer to Spec Sheet for Complete Information and Availability.

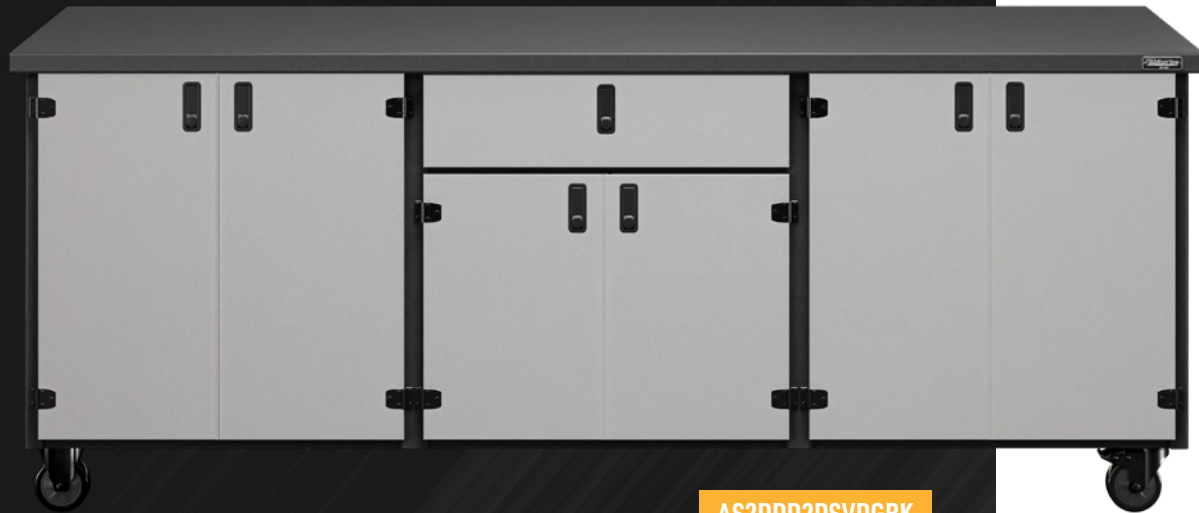

AS2DDD2DSVDGBK



ASBL2DBXTBCHBK

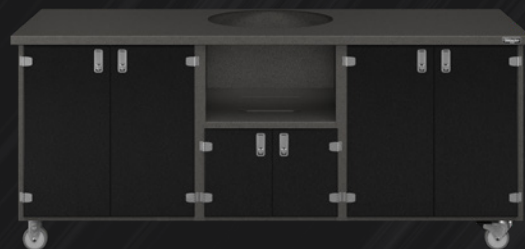

AS2DBL2DSVBKSS

TRIO

ALPHA SERIES

- This model is customizable with 4-6 Doors, Drawer Options, or Gas Grill.
- Available for the Big Green Egg, Kamado Joe, Primo and more.
- Length and Width will vary by Grill Brand.
- Refer to Spec Sheet for Complete Information and Availability.



AS2D2D2DSVBK BK



ASDDSVBK BK

ACCESSORY ALPHA SERIES

Running out of space for all of your accessories, and anything extra you want to bring outdoors? Accessory Cabinets are here for you! These cabinets can be fully customized to meet your individual needs. Modules come in a range from single, double, or triple section cabinets, with drawer options available. Whether it's your grilling tools or gardening tools, Accessory Cabinets make space for you and adds working area. Cabinets can be fully customized with all of our Alpha Series color and finish options.



PELLET GRILL

ALPHA SERIES

Crafted with the same high standards as the rest of the Alpha Series, our pellet grill cabinets are ready to meet your grilling needs. With ample space for pellets, grilling accessories, seasonings and everything else you need, these cabinets that will stand the test of time!

Since not all pellet grills are the same, these cabinets are fully customizable to meet the specs of your grill and provide a quality BBQ experience for years to come.



CUSTOMIZED ALPHA SERIES

If you're looking for something to fit a particular space, but don't see a stock option that works, we offer custom options. We'll help design cabinets for your space, then build them to match to ensure long-term satisfaction. Ask us for more information.

ALPHA SERIES FEATURES

- 1 Body and Top:** UV and chip resistant powder coated $\frac{1}{8}$ " welded aluminum. Lightweight, exceptionally durable surface for outdoor use. Cleans easily with mild soap and a soft cloth.
- 2 Doors:** Marine grade and UV resistant $\frac{1}{2}$ " polyethylene doors are finished with a secure door latch and D-trim weather stripping to provide protection for all your grilling items.
- 3 Hardware:** Powder coated and stainless hardware fulfill the rugged construction requirements of any climate. The commercial trigger latch and hinges provide security as well as functionality for every day use.
- 4 Drawer Slides:** Non-mechanical drawer slides are built to last, with no corrosion, rust, or binding.
- 5 Casters:** 4" stainless steel casters for years of dependable outdoor use. They also allow for easy maneuverability on rough, uneven surfaces while holding securely when locked.



METAL DRAWER GUIDES



DOOR MATERIALS

ALPHA SERIES PRODUCT COLOR OPTIONS

Door Colors

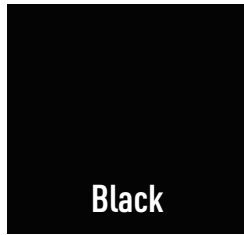

Black



Charcoal Gray

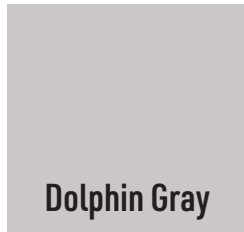

Dolphin Gray



Evergreen



Mocha Brown

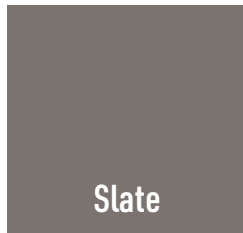

Slate

- 1 UV resistant 1/2" polyethylene
- 2 Will not corrode, tarnish, fade or rot
- 3 Provides a long lasting and elegant look in all 5 colors

Powder Coated Body/Top

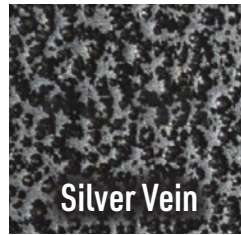

Silver Vein



Speckled Oak



Tuxedo Black



Weather Vein

Extra Heavy Duty Hardware



STAINLESS STEEL



BLACK POWDER COAT



- 1 Powder Coated and Stainless Hardware
- 2 Durable in all climate regions

- 1 UV & Chip Resistant powder coated 1/8" welded aluminum
- 2 Exceptionally durable
- 3 Easily cleaned with mild soap and a soft cloth, maintaining a fresh look in all types of environments

Note: Actual colors may vary due to differences in printing and/or screens. Dealer samples are available.

ALPHA SERIES NAMING GUIDE

AS	BL	DD	**	SV	DG	BK			
ALPHA SERIES	1 ST SECTION/ SOLO CABINET	2 ND SECTION <i>ADD FOR DUO CABINET</i>	3 RD SECTION <i>ADD FOR TRIO CABINET</i>	BASE AND TOP FINISH		DOOR COLOR		HARDWARE FINISH	
	CART SECTION CONFIGURATION <i>CHOOSE EITHER A DOOR OPTION OR GRILL CONFIGURATION FOR EACH SECTION</i>								
	DOOR OPTION			SV	Silver Vein	BK	Black	BK	Black Powder Coat
	2D	2 Door		SO	Speckled Oak	CH	Charcoal Gray	SS	Stainless Steel
	DD	2 Door w/ Drawer		TB	Tuxedo Black	DG	Dolphin Gray		
	BIG GREEN EGG			WV	Weather Vein	GR	Evergreen		
	BL	18" Large				MB	Mocha Brown		
	BX	24" XLarge				SL	Slate		
	BZ	29" XXLarge							
	KAMADO JOE								
	KC	18" Classic							
	KB	24" Big Joe							
	PRIMO								
	PK	18.5" Kamado							
	P3	Oval L 300							
	P4	Oval XL 400							
	COYOTE								
	CA	22" Asado							



EXAMPLE CONFIGURATION: ASBLDDSDVGBK

AS - Alpha Series | BL - Big Green Egg 18" Large Grill Section | DD - 2 Door with Drawer Section | SV - Silver Vein Base and Top Finish | DG - Dolphin Gray Door Color | BK - Black Powder Coat Hardware Finish.

Wellspring Alpha Series Cabinets are identified by up to 14 letters set in combinations of two letters each. Accessory cabinets are named using only door options in each section. Use the above chart for reading Cabinet Names. Refer to spec sheet for complete information and availability.

ALPHA SERIES COLOR EXAMPLES



SILVER VEIN/BLACK/STAINLESS
- ASBLDDSVBKSS



TUXEDO BLACK/DOLPHIN GRAY/BLACK
- ASBLDDTBDGBK

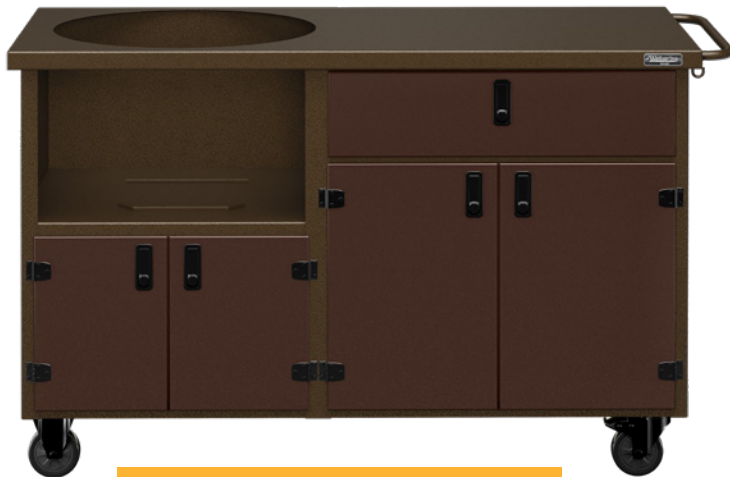

WEATHER VEIN/MOCHA BROWN/BLACK
- ASBLDDWVMBBK



SILVER VEIN/EVERGREEN/STAINLESS
- ASBLDDSVGRSS





XPANDABLE GENERATION SERIES

The Xpandable Generation Series is the basis for your fully customized kitchen space. When the same durable powdercoated finish and polyethylene doors are combined with a 2" removable top and standard widths, the only limit is your imagination.

Welcome to the Xpandable Generation Series. From mobile cabinets and stationary islands up to full service custom kitchens, the Xpandable Generation is made just for you. Each cabinet is built with 1/8" aluminum that is fully welded and requires no assembly. We use standard cabinet widths to ensure maximum flexibility both now and in the future. Our removable 2" powdercoated top allows for different sized tops or replacement tops to be easily added later. UV resistant 1/2" polyethylene doors will not rot or fade and will provide elegance and protection for many years to come. Our bar pull kitchen handles bring durability and style to your kitchen. Cabinets come standard with our 4" heavy duty casters, leg

kits available for stationary designs. The Xpandable cabinets can fit a full range of built in gas grills or ceramic kamado style grills. When choosing a different grill, we simply resize the grill section to fit within the same standard footprint.

Don't need a grill section? We've got you covered! You can choose from various combinations of accessory cabinets, wastebaskets sections, and sink options, as well as drawer options. Make your kitchen stand above the rest with a urethane counter top upgrade that adds durability and gives your kitchen an authentic granite or marble look. The Xpandable cabinets are here to grow with your outdoor cooking needs.



EXBL2DSVSVCHBKCS



EXBLDDTBWVDGSSCS

DUO XPANDABLE SERIES

- Duo Modules are 30"W x 57½"L x 34"H. Section width will vary based on grill model chosen.
- Simply change the top to change to any other ceramic grill brand.
- With a plain top, this module can be used as an accessory cabinet in 6 plus different configurations.



EX1DGM1DSVSVCHBKCS

TRIO

XPANDABLE SERIES

- Trio Modules are 30"W x 80"L x 34"H. Section width will vary based on grill model chosen.
- 4 Doors Includes Tank Storage / 2 Drawer
- Top And Front Filler Are Custom Made To Grill Size
- Able to fit any built-in Grill options.



ACCESSORY XPANDABLE SERIES

Running out of space for all of your accessories, and anything extra you want to bring outdoors? Accessory Cabinets are here for you! These cabinets can be fully customized to meet your individual needs. Modules come in double or triple section cabinets, with drawer options available. Whether it's your grilling tools or gardening tools, Accessory Cabinets make space for you and adds that much desired working area. Cabinets can be fully customized with all of our Xpandable Series color and finish options.



KITCHEN XPANDABLE SERIES

Looking for a built-in option for your space? We offer the Xpandable series with a fixed leg option that's ideal for installation purposes. They can be easily connected to each other, end to end or with a corner top to create a L- or U-shaped outdoor kitchen. Cabinets can be fully customized with all of our Xpandable Series color and finish options. We also offer completely customized options such as corner grill cabinets and full height cabinets as pictured. For additional layout ideas, see examples on page 32.



XPANDABLE SERIES DETAILS



Duo Accessory Module:

- All Duo Modules; 30"W x 57½"L x 34"H
- The same module can be used with a top for any specific brand ceramic grill.
- With a plain top this module can be used as an accessory cabinets in 6 plus different configurations.
- They can be easily connected to each other, end to end or with a corner top to create a L- or U-shaped outdoor kitchen.



Trio Accessory Module:

- All Trio Modules; 30"W x 80"L x 34"H
- 4 Doors / 2 Drawers / 1 Open Shelf
- Putting a full top on the gas module creates an accessory module. A blank front can be ordered for the open area.
- Front filler can be replaced with a blank front.



Corner Top Kit:

- Corner Top; 30"W x 30"L x 34"H
- Includes 1 Adjustable Support Leg and Trim
- Optional Umbrella Hole
- Inside Corner Trim; 29¾"L
- Spacer T Trim: 29¾"L
- Works on either end of modules, providing a nearly seamless connection.

XPANDABLE SERIES FEATURES

- 1 Body and Top:** UV and chip resistant powder coated $\frac{1}{8}$ " welded aluminum. Lightweight, exceptionally durable surface for outdoor use. Cleans easily with mild soap and a soft cloth. Upgraded Urethane top with UV resistant clear coat finish available.
- 2 Doors:** Marine grade and UV resistant $\frac{1}{2}$ " polyethylene doors with D-trim weather stripping to provide protection for all your grilling items.
- 3 Hardware:** Kitchen style powder-coated and stainless hardware. Hinges are hidden behind doors.
- 4 Drawer Slides:** Soft close, full extension, side mount drawer glides are standard on all pieces.
- 5 Casters:** 4" stainless steel casters for years of dependable outdoor use. They also allow for easy maneuverability on rough, uneven surfaces while holding securely when locked.



$\frac{1}{2}$ " DOOR PROFILE



GAS GRILL OPTIONS



STAINLESS STEEL GUIDES

XPANDABLE SERIES NAMING GUIDE

EX	BL	DD	TD	CP	GR	SS	CS							
XPANDABLE GENERATION	DUO CABINETS CART SECTION CONFIGURATION <i>CHOOSE DOOR OPTION OR GRILL CONFIGURATION FOR SECTION 1</i>		BASE FINISH	TOP COLOR	DOOR COLOR	HARDWARE FINISH	STAND TYPE							
	1 ST SECTION		2 ND SECTION											
	DOOR OPTION		DOOR OPTION		SV	Silver Vein	SV	Silver Vein	BK	Black	BK	Black	LK	Leg Kit
	2D	2 Door	2D	2 Door	SO	Speckled Oak	SO	Speckled Oak	CH	Charcoal Gray	SS	Stainless	CS	Casters
	DD	2 Door w/ Drawer	DD	2 Door w/ Drawer	TB	Tuxedo Black	TB	Tuxedo Black	DG	Dolphin Gray				
	DS	2 Door w/ Open Shelf			WV	Weather Vein	WV	Weather Vein	GR	Evergreen				
	DB	2 Door w/ Blank Front							MB	Mocha Brown				
	BIG GREEN EGG				UPGRADE - CATALYZED URETHANE		SL	Slate						
	BL	18" Large			AG	Astoria Granite								
	BX	24" XLarge			CP	Cappuccino								
	BZ	29" XXLarge			CG	Charcoal Granite								
	KAMADO JOE				NS	Night Spots								
	KC	18" Classic												
	KB	24" Big Joe												
	PRIMO													
	PK	18.5" Kamado												
	P3	Oval L 300												
	P4	Oval XL 400												



EXAMPLE CONFIGURATION: EXBLDDTDCPGRSSCS

Xpandable Series Cabinets are identified by up to 18 letters set in combinations of two letters each. Duo Cabinets may have a ceramic grill option only in the 1st section. Accessory cabinets have only door options in each section. Please consult other literature for more extensive product details.

EX - Xpandable Series | BL - Big Green Egg 18" Large Grill Section | DD - 2 Door with Drawer Section | TD - Tuxedo Black Base | CP - Cappuccino Top Finish | GR - Evergreen Door Color | SS - Stainless Steel Hardware Finish | CS - Casters.

EX	1D	GM	1D	SV	SV	CH	BK	CS								
XPANDABLE GENERATION	TRIO CABINETS CART SECTION CONFIGURATION <i>CHOOSE EITHER A DOOR OPTION OR GAS GRILL CONFIGURATION FOR SECTION 2</i>			BASE FINISH		TOP COLOR		DOOR COLOR		HARDWARE FINISH		STAND TYPE				
	1 ST SECTION		2 ND SECTION		3 RD SECTION											
	DOOR OPTION		DOOR OPTION		DOOR OPTION											
	1D	1 Door w/ Drawer	DS	2 DR w/ Open Shelf	1D	1 Door w/ Drawer	SV	Silver Vein	SV	Silver Vein	BK	Black	BK	Black	LK	Leg Kit
	2D	2 Door	DB	2 DR w/ Blank Front	DD	2 Door w/ Drawer	SO	Speckled Oak	SO	Speckled Oak	CH	Charcoal Gray	SS	Stainless	CS	Casters
	DD	2 Door w/ Drawer	GAS GRILL				TB	Tuxedo Black	TB	Tuxedo Black	DG	Dolphin Gray				
	DS	2 DR w/ Open Shelf	GM	24" - 38"			WV	Weather Vein	WV	Weather Vein	GR	Evergreen				
	DB	2 DR w/ Blank Front					UPGRADE - CATALYZED URETHANE		MB	Mocha Brown	SL	Slate				

Gas grill option in the 2nd section only. Accessory cabinets select only door options. Please consult other literature for more precise color options and further product details.

EX	1D	SV	SV	CS				
XPANDABLE GENERATION	CORNER MODULE		BASE FINISH		TOP COLOR		STAND TYPE	
	CW	Corner Wedge	SV	Silver Vein	SV	Silver Vein	LK	Leg Kit
	CU	Corner for Umbrella	SO	Speckled Oak	SO	Speckled Oak	CS	Casters
			TB	Tuxedo Black	TB	Tuxedo Black		
			WV	Weather Vein	WV	Weather Vein		
			UPGRADE - CATALYZED URETHANE					
		AG	Astoria Granite					
		CP	Cappuccino					
		CG	Charcoal Granite					
		NS	Night Spots					

Corner Modules enhance kitchen layouts. Includes option for umbrella.

AG	Astoria Granite
CP	Cappuccino
CG	Charcoal Granite
NS	Night Spots



EXAMPLE CONFIGURATION: EX1DGM1DSVSVCHBKCS

EX - Xpandable Series | 1D - Door w/ Drawer | GM - Gas Grill | 1D - Door w/ Drawer | SV - Silver Vein Base Finish | SV - Silver Vein Top Finish | CH - Charcoal Door Color | BK - Black Powder Coat Hardware Finish | CS - Casters.

XPANDABLE SERIES PRODUCT COLOR OPTIONS

Door Colors

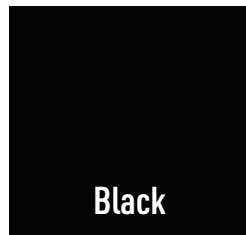

Black



Charcoal Gray

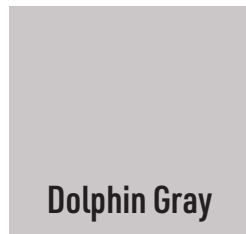

Dolphin Gray

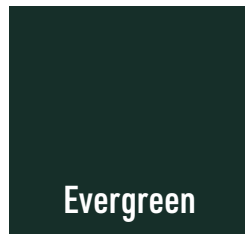

Evergreen

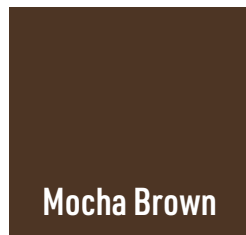

Mocha Brown

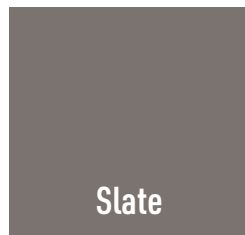

Slate

- 1 UV resistant 1/2" polyethylene
- 2 Will not corrode, tarnish, fade or rot
- 3 Provides a long lasting and elegant look in all 5 colors

Powder Coated Body/Top



Silver Vein

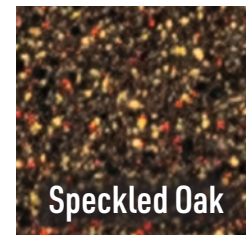

Speckled Oak

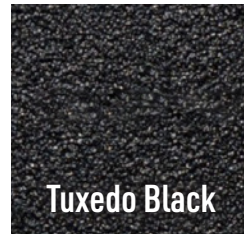

Tuxedo Black



Weather Vein

Urethane Top Colors

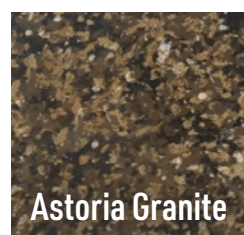

Astoria Granite

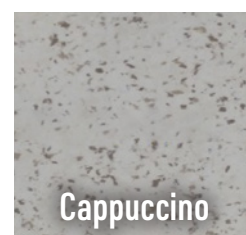

Cappuccino

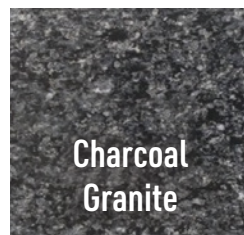

Charcoal Granite

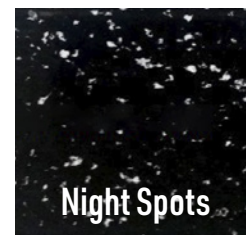

Night Spots

- 1 UV & Chip Resistant powder coated 1/8" welded aluminum
- 2 Exceptionally durable
- 3 Easily cleaned with mild soap and a soft cloth, maintaining a fresh look in all types of environments

- 1 A unique and highly durable two part catalyzed urethane with UV resistant clear coat in an authentic granite counter look and feel.

- 2 This upgrade makes the Xpandable Cabinet the most unique modular kitchen on the market.

Note: Actual colors may vary due to differences in printing and/or screens. Dealer samples are available.

XPANDABLE SERIES ADDITIONAL OPTIONS

ADDITIONAL COLOR COMBINATIONS



XGBLDDTBDGSS

XGBLDDSVCPCHSS



XGBLDDTBMBBK

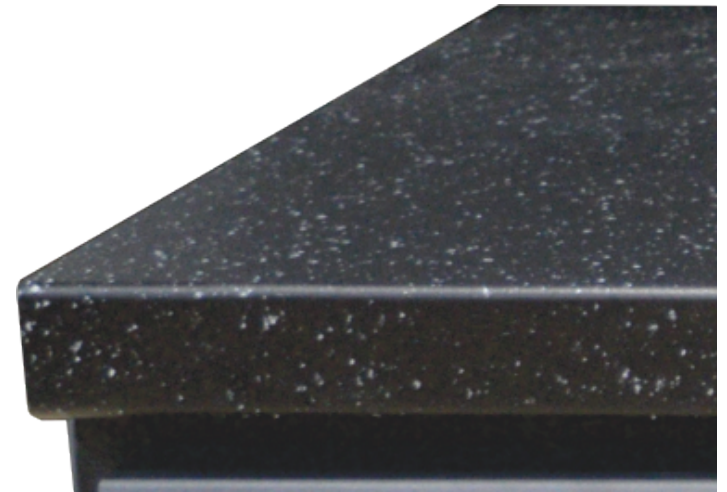

COUNTERTOP UPGRADE

The Xpandable Series may be upgraded with an all aluminum top featuring a unique and highly durable two part catalyzed urethane finish as is used extensively in refurbishing kitchen counter tops. Covered with a UV resistant clear coat, this top provides an authentic granite counter look and feel and makes the Xpandable Series the most unique modular kitchen on the market. Save weight and prevent rotting with this easy to install upgrade, rather than using marble, wood, or other standard counter top materials.

XPANDABLE SERIES EXAMPLE KITCHEN LAYOUT GUIDE

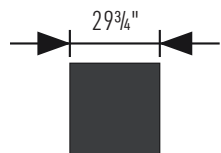

Corner Wedge

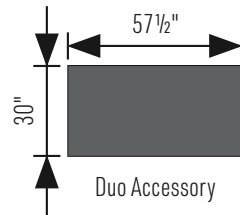

Duo Accessory

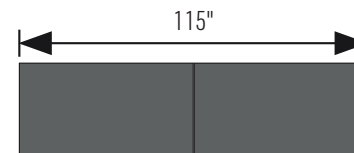

(2) Duo Accessory

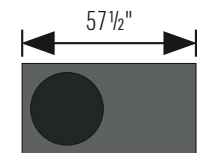

Duo Grill

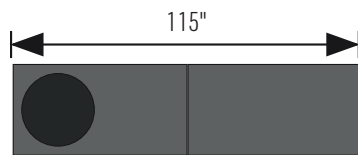

Duo Grill Module & Duo Accessory

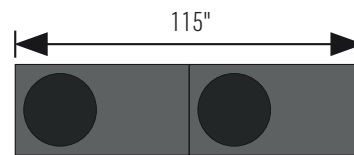

(2) Duo Grill Module

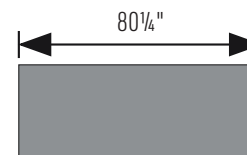

Trio Accessory Module

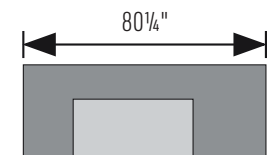

Trio Gas Grill Module

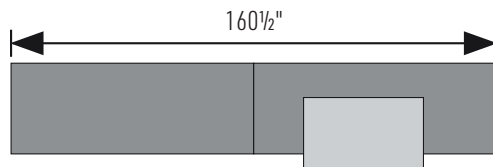

Trio Accessory & Trio Gas Grill

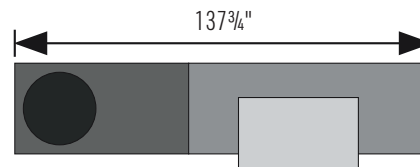

Duo Grill & Trio Gas Grill

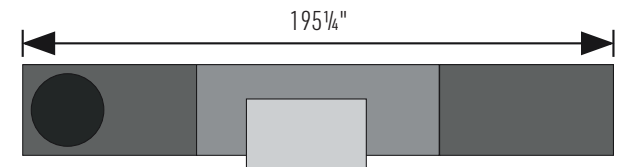

Duo Grill Module, Trio Gas Grill, & Duo Accessory

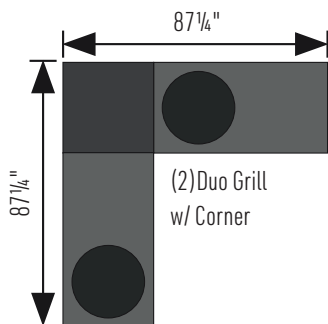

(2) Duo Grill
w/ Corner

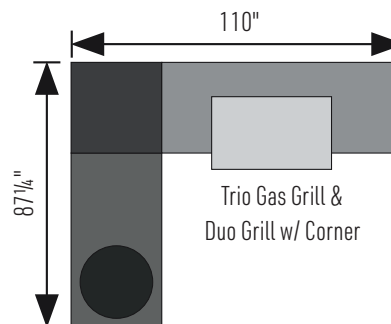

Trio Gas Grill &
Duo Grill w/ Corner

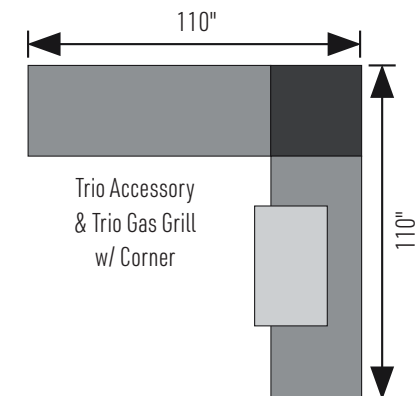

Trio Accessory
& Trio Gas Grill
w/ Corner

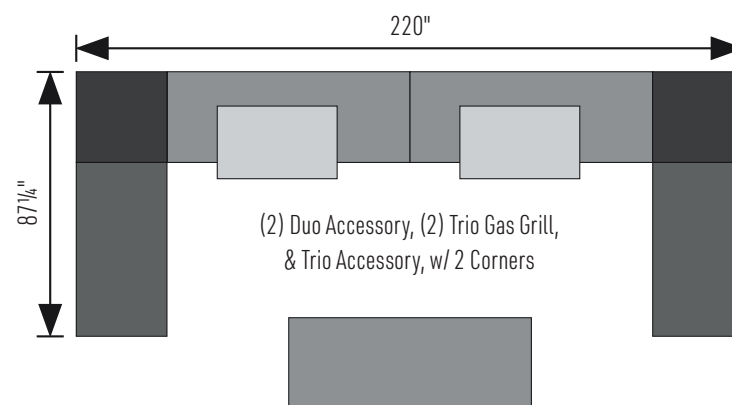
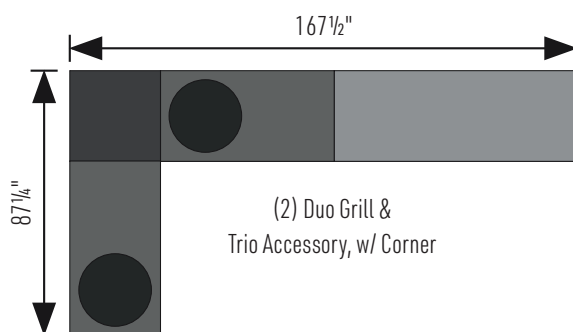
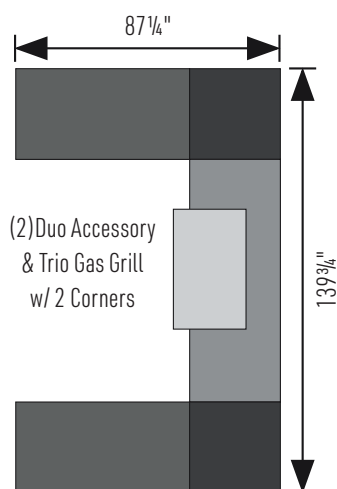
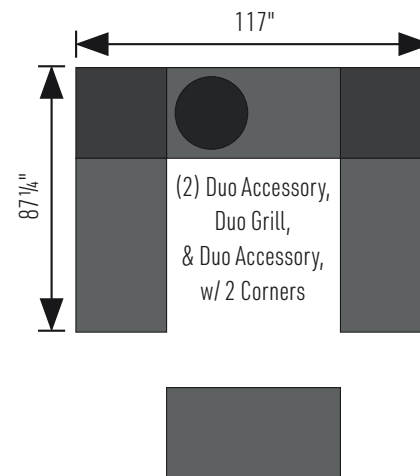
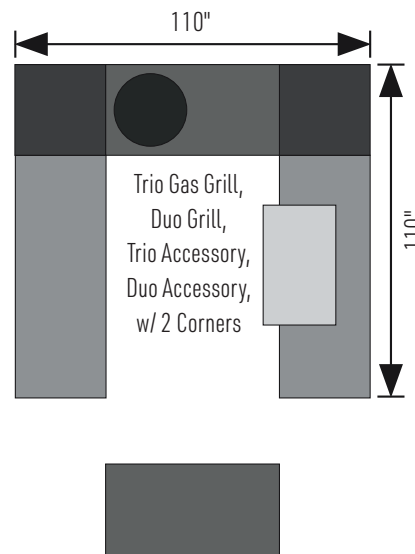
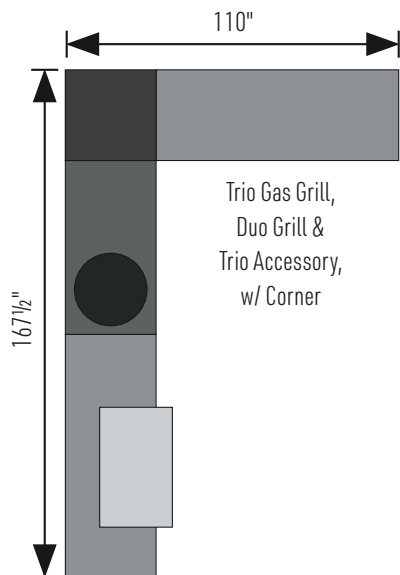
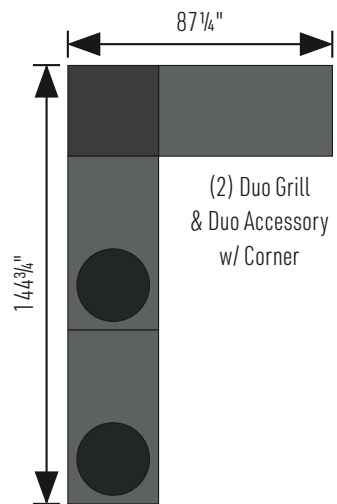



Additional Accessories

- Powder Coat Color Option
- Vinyl Grill Cover
- Silicone Fiberglass Mat

Product Specifications

- Grill: Large Big Green Egg
- Weight: 52lbs.
- Dimensions: 50"L x 24"W x 34"H
- Cabinet: 8 Ga. Aluminum Body
- Finish: UV Resistant Powder Coating, 140° F. Maximum, Remelt Temp. 350°F.
- Casters: 4" Heavy Duty Full Locking
- Leg Kit: Adjustable Leveling, All Welded Powder Coated Aluminum.

CLASSIC

COLLAPSIBLE CABINETS SERIES

The Classic Collapsible Cabinets Series is an original line of powder coated aluminum, all-weather outdoor grill carts by Wellspring which may be disassembled for shipping and storage.

The all-weather finish can be cleaned up with mild soap and a soft cloth. Counter tops are the same material and require the use of hot plates or heat resistant protective mats. Accompanied by 4" casters, this cart can be easily moved on a variety of outdoor surfaces. Once positioned, the 2-way locking casters also provide a stable and stationary work

station. The Classic Ruggedness Series is designed for easy shipping and includes Free Shipping to all customers in the lower 48 states and can be added to existing orders with no additional shipping cost. Same day shipping options also available. All hardware included for assembly with instructions.



CLASSIC VALUE SERIES

If you are just getting into the grilling market, you have probably noticed that it is not the cheapest hobby to get into. Not to worry! Wellspring has a great cart for those of you who are just getting into grilling, or have multiple grills and want to keep them mobile. Value carts are a great accessory to cooking experience. Carts come in powder coated Tuxedo Black, in your choice of aluminum or steel, and are available for Big Green Egg, Kamado Joe, and Primo.



PATIO TABLE

6 PERSON w/CHAIRS

- Bar Height Table: 60"L x 30"D x 34¾"H
- Standard Chairs: 18"W x 18"D x 31"H (18" seat height)
- Barstools: 18"W x 18"D x 35"H (22" seat height)
- Backless Barstools: 18"W x 18"D x 23"H (22" seat height)
- Seat Size: 14"W x 14"D
- Aluminum construction on base & frame with powder coated finish.
- Poly table top insert.
- 2" thick aluminum thick top frame.
- Customizable, more colors available.
- Available in table, counter & bar height.



These sauces and seasonings are proven to provide the best in barbecue. The Sweet & Savory, BBQ Plus & Meat Rub have won many prizes. Combined, they are a complete seasoning cupboard for serious barbeque.





SAUCES & SEASONINGS

AWARD WINNING

No BBQ is complete without spices. Our award-winning sauces and seasonings are proven to provide the best in barbecue and are a great compliment to your BBQ store.

Welcome to our spice and seasoning selection, your ultimate culinary companion where you will find multiple award-winning selections! Our Sweet & Savory BBQ Sauce has won such prizes as the Best Sauce in the 2015 American Royal and the 2019 Illinois Peoples Choice. BBQ Plus & Meat Rub have also won many prizes and combined are a complete seasoning cupboard for serious barbeque. Whether you are an aspiring home cook or a seasoned chef,

our treasure trove of flavors found throughout our carefully curated collection of aromatic herbs, spices, and unique blends will elevate your culinary creations to new heights.

From bold and smoky to sweet and savory, let your taste buds be your guide as you embark on your culinary journey. Happy cooking!

BAR-B-QUE SAUCES



SWEET & SAVORY BBQ SAUCE

This is one of those products that we feel great in putting our name on it. This is for those that love a sweet barbeque sauce. The brown sugar performance in this savory sauce works great on any type of meat. Go ahead, don't just pour, smother it!

Available Sizes:

1/2 Gallon (6 Per Case)
12 oz. bottle (12 Per Case)



SPICY PEACH BBQ & WING SAUCE

The smooth sweetness of this sauce blends with the medium to mild spice flavors in such a way that you can hardly pinpoint the peach! When you slather chicken wings with this, you'll know it's taking barbeque sauce to another realm.

Available Sizes:

1/2 Gallon (6 Per Case)
12 oz. bottle (12 Per Case)



SPICE SAMPLER

Includes sample sized bottles of our Fajita & Wings, Meat Rub, BBQ+ and Steak & Burger.

Available Sizes:

4 Pack

RUBS & SEASONINGS



MEAT-RUB

Fully developed in house, this all-purpose meat rub combines the spices of Rub-Rub with a little sweetness, helping seal in the natural juices of any meat that is cooked low and slow in the barbeque pit. This is the ultimate for ribs, pork tenderloin, briskets, whole chickens and more. Apply just before putting meat on barbeque pit or up to 12 hours before cooking, wrapping and refrigerating.

Available Sizes:

2 lb Bag
10½ oz. Shaker Bottle



BBQ PLUS

Our signature product has been developed over a period of years to a tasty balance of salt, sugar, onions, garlic, black pepper, hickory smoke flavor, chilli, and spices. This is the ultimate for grilled chicken, sealing in natural juices of your meat. The taste of grilled chicken seasoned with BBQ Plus will encourage you to BBQ Plus everything.

Available Sizes:

5 lb. Bag | 2 lb Bag
10½ oz. Shaker Bottle



STEAK & BURGER

This recipe is based on a Montreal Steak seasoning. The overall grind is a little finer than most steak seasonings, but still a fairly course ground peppercorn. A little less garlic for those that don't want the taste dominated by garlic. The finer grind makes it great for burgers. Press on both sides of steak at time of grilling or apply up to 4 hours before.

Available Sizes:

10½ oz. Shaker Bottle



FAJITA SEASONING

This is our new sensation in the food world. The medium heat chili that we use creates a south-of-the-border sensation without overwhelming the flavor of your food. Great for chicken and beef fajitas, but very universal. You'll be surprised what it'll do for stir-fries, shrimp and steaks.

Available Sizes:

2 lb Bag
10½ oz. Shaker Bottle

SAUCES & SEASONINGS



TACO/ENCHILADA

Tacos: Use more or less to adjust heat. Great for any taco dish.

Enchiladas: Use some seasoning in the meat, not too much. Heat 2 c. tomato juice in a sauce pan. Mix 2 tbsp seasoning with 2 tbsp corn starch or flour. Whip mixture into the tomato juice and let simmer until it thickens a little. Ladle some of the sauce into the meat for flavor and moisture. After the Enchiladas are rolled into a pan, pour sauce over the top. Bake and add cheese when close to being done.

Available Sizes:

8 oz. Shaker Bottle



SRIRACHA

Throw out your hot pepper and try this flavorful blend to satisfy your special taste buds. Habanero with enough sweet and tangy to create a sensational flavor on meats, eggs and vegetables.

Available Sizes:

8 oz. Shaker Bottle



ITALIAN

This combination of spices is a great blend to bring that unique Italian flavor to about anything you wish. Has no salt or sugar, just bursting with flavor. Ready for your soups, pizza and pasta.

Available Sizes:

3 oz. Shaker Bottle



ORGANIC COFFEE



BALI (INDONESIA)

Medium Roast

Very low acidity. For sensitive stomachs. A well-balanced, organically grown coffee with a very unique flavor profile. It has notes of Black Licorice and Cedar.

Available Sizes:

- 12 oz. Zipper Seal Bags
- 12 count K-Cups



JAVA (INDONESIA)

Medium/Dark Roast

Low acidic. A great flavor from the island of Java. A low acidic coffee that has a rich chocolate undertone with a smooth finish.

Available Sizes:

- 12 oz. Zipper Seal Bags
- 12 count K-Cups



OAXACA (MEXICO)

Medium Roast

Very mild acidity. For sensitive stomachs. A surprising mellow experience from Oaxaca region of Mexico. Brown sugar with milk chocolate notes.

Available Sizes:

- 12 oz. Zipper Seal Bags
- 12 count K-Cups



SULAWESI (CELEBES)*

Dark Roast

An Arabica bean that has a robustic flavor. It is low acidic. A rare coffee from small farmers in Indonesia. It possesses deep flavors with a mellow aftertaste compared to the well known Sumatran.

Available Sizes:

- 12 oz. Zipper Seal Bags
- 12 count K-Cups

**Non-Organic*



Wellspring

COMPONENTS, LLC

1085 N. 850 W. | Shipshewana, IN 46565
orders@wellspringllc.us | wellspringbbq.com

Call Today: 260-768-7336

For more information,
contact your nearest Wellspring dealer
or Wellspring Components.

ENHANCE YOUR BACKYARD WITH A CUSTOM GRILL CABINET

BUILT IN SHIPSHEWANA, INDIANA, USA.